

Installation and user's guide

MULTICAL® 603



## Information

---

### Permissible operating conditions / measuring ranges

Heat meter with approval according to MID and EN1434:

Temperature range  $\Theta$ : 2 °C...180 °C  $\Delta\Theta$ : 3 K...178 K

ULTRAFLOW® (temperature of medium)  $\Theta_q$ : 15 °C...130 °C

Cooling meter with approval according to DK-BEK 1178 and EN1434:

Temperature range  $\Theta$ : 2 °C...180 °C  $\Delta\Theta$ : 3 K...178 K

ULTRAFLOW® (temperature of medium)  $\Theta_q$ : 2 °C...130 °C

### MID designation

#### Mechanical environment

Class M1 and M2

#### Electromagnetic environment

Class E1 (housing/light industry) and class E2 (industry). The meter's control cables must be drawn at min. 25 cm distance from other installations.

#### Climatic environment

Non-condensing, closed location (installation indoors), ambient temperature 5...55 °C.

#### Maintenance and repair

The energy supplier can replace temperature sensor pairs, flow sensor as well as supply and communication modules. Other repairs require subsequent reverification in an accredited laboratory.

#### Selecting a temperature sensor pair

MULTICAL® 603-A - Pt100 Pt100 - EN 60751, 2-wire connection

MULTICAL® 603-B - Pt100 Pt100 - EN 60751, 4-wire connection

MULTICAL® 603-C/E/F - Pt500 Pt500 - EN 60751, 2-wire connection

MULTICAL® 603-D/G - Pt500 Pt500 - EN 60751, 4-wire connection

#### Battery for replacement

Kamstrup type HC-993-09 (2 x A-cells)

Kamstrup type HC-993-02 (1 x D-cell)

#### Communication Modules

An overview of available modules is found in the paragraph Communication modules.

# Contents

---

<b>1</b>	<b>General information</b>	<b>4</b>
<b>2</b>	<b>Mounting of temperature sensors</b>	<b>5</b>
	2.1 Short direct sensor (DS)	5
	2.2 Pocket sensor (PL)	6
<b>3</b>	<b>Mounting of flow sensor</b>	<b>7</b>
	3.1 Mounting of couplings and short direct sensor in flow sensor	7
	3.2 Mounting of ULTRAFLOW® ≤ DN125	8
	3.3 Mounting of ULTRAFLOW® 54 ≥ DN150	8
	3.4 Flow sensor position	9
	3.5 Installations with two ULTRAFLOW® sensors	10
<b>4</b>	<b>Mounting the calculator</b>	<b>11</b>
	4.1 Compact mounting	11
	4.2 Wall-mounting	11
<b>5</b>	<b>Electrical connection</b>	<b>12</b>
	5.3 Cable Extender Box	12
	5.4 Electrical connection of Pulse Transmitter	12
	5.1 Connection of temperature sensors	12
	5.2 Connection of ULTRAFLOW®	12
	5.5 Connection of other flow sensors	13
	5.7 Internal communication	13
	5.6 Connection of power supply	13
<b>6</b>	<b>Testing of function</b>	<b>14</b>
<b>7</b>	<b>Information code</b>	<b>15</b>
<b>8</b>	<b>Communication Modules</b>	<b>16</b>
	8.1 Module overview	16
	8.2 Pulse inputs	16
	8.3 Pulse outputs	17
	8.4 Data + pulse inputs, type HC-003-10	17
	8.5 Data + pulse outputs, type HC-003-11	17
	8.6 M-Bus + pulse inputs, type HC-003-20	18
	8.7 M-Bus + pulse outputs, type HC-003-21	18
	8.8 M-Bus + Thermal Disconnect, type HC-003-22	18
	8.9 Wireless M-Bus + pulse inputs, type HC-003-30	19
	8.10 Wireless M-Bus + pulse outputs, type HC-003-31	19
	8.11 Analog outputs, type HC-003-40	19
	8.12 Analog inputs, type HC-003-41	20
	8.13 PQT Controller, type HC-003-43	20
	8.14 LON TP/FT + pulse inputs, type HC-003-60	21
	8.15 BACnet MS/TP + pulse inputs, type HC-003-66	21
	8.16 Modbus RTU + pulse inputs, type HC-003-67	21
<b>9</b>	<b>Set-up via front keys</b>	<b>22</b>

# 1 General information

---

- ⚠ Please read this guide carefully before installing the energy meter.**  
**In case of incorrect mounting, Kamstrup's guarantee obligations no longer apply.**  
**By connecting to 230 V supply, there is a risk of electric shock.**  
**When working on the flow sensor in the installation, there is a risk of outflow of (hot) water under pressure.**  
**At a media temperature higher than 60 °C, the flow sensor should be shielded from unintended contact.**

Please note that the following installation conditions must be obeyed:

- Pressure stage Kamstrup ULTRAFLOW®: PN16/PN25/PN40, see marking. The meter marking does not apply to enclosed accessories.
- Pressure stage Kamstrup sensor pair, type DS: PN16
- Pressure stage Kamstrup pocket sensors, type PL: PN25

At media temperatures above 90 °C, we recommend flange sensors as well as wall-mounting of MULTICAL®.

At media temperatures below the ambient temperature, MULTICAL® must be wall-mounted, and the flow sensor must be a condensation-proof version.

## 2 Mounting of temperature sensors

The temperature sensors used for measuring inlet and outlet temperatures respectively, constitute a matched sensor pair, which must never be separated. Temperature sensors are usually mounted in the calculator from the factory. According to EN 1434/OIML R75 the cable length must not be changed. Should replacement be necessary, both sensors must be replaced. The sensor marked with a red sign is to be installed in the inlet pipe. The other sensor, marked with a blue sign, is to be installed in the outlet pipe. For mounting in the calculator, see the paragraph "Electrical connection".

**Note:** The sensor cables must neither be exposed to jerking nor pulling. Please be aware of this when binding the cables, and be careful not to pull the binders unnecessarily tight as this may damage the cables. Please also note that temperature sensors must be mounted from below in cooling and heat/cooling installations.

### 2.1 Short direct sensor (DS)

The short, direct sensors up to DN25 can be mounted in special ball valves with built-in M 10 socket for the short direct sensor. They can also be mounted in installations with standard tee-pieces. Kamstrup A/S can supply R $\frac{1}{2}$  and R $\frac{3}{4}$  brass nipples that fit our short direct sensors. The short direct sensor can be also be mounted directly in selected flow sensors from Kamstrup A/S. Fasten the sensors' brass unions lightly (approx. 4 Nm) using a 12 mm face wrench, and seal the sensors with seal and locking wire.

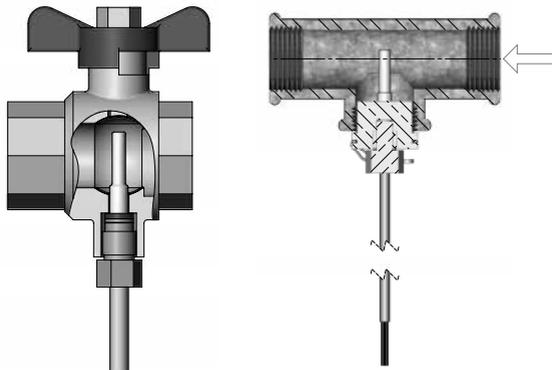

## 2.2 Pocket sensor (PL)

The sensor pockets can be mounted in e.g. a welding sleeve or in a 45° lateral Y-piece. The tip of the sensor pocket must be placed in the middle of the flow. Push the temperature sensors as deep as possible into the pockets. If a short response time is required, "non-hardening" thermally conductive paste can be used. Push the plastic sleeve on the sensor cable into the sensor pocket and secure the cable by means of the enclosed M4 sealing screw. Fasten the screw with your fingers only. Seal the pockets using seal and locking wire.

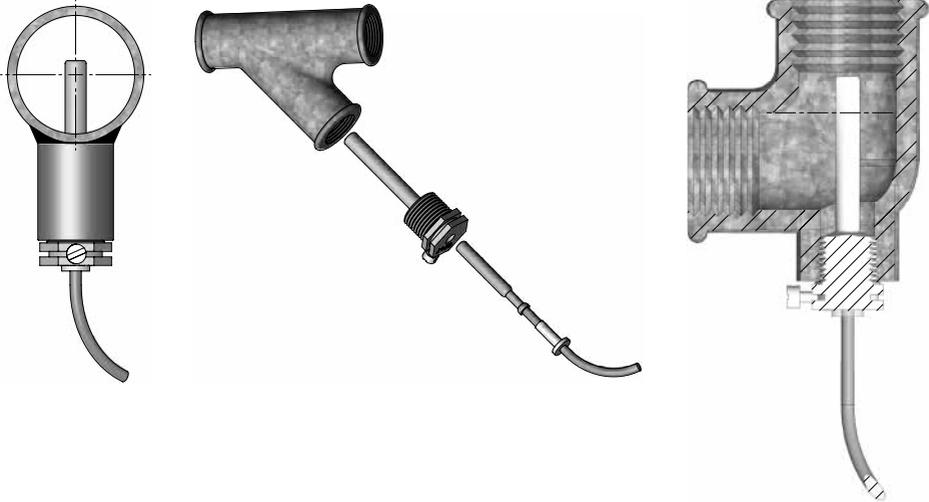

### 3 Mounting of flow sensor

Prior to installation of the flow sensor, the system should be flushed and protection plugs/plastic diaphragms removed from the flow sensor.

Correct position of the flow sensor appears either from the calculator's type label or from the display where  symbolises the position in inlet, whereas  indicates the position in outlet. The flow direction is symbolised by an arrow on the flow sensor.

#### 3.1 Mounting of couplings and short direct sensor in flow sensor

The short direct sensor from Kamstrup may be installed in PN16 installations only. Flow sensor and any mounted blind plug can be used in connection with both PN16 and PN25. The flow sensor is available with either PN16 or PN25 marking as required. Enclosed couplings, if any, are only intended for PN16. Suitable PN25 couplings must be used in PN25 installations.

**In connection with flow sensors with the nominal dimensions G $\frac{3}{4}$ Bx110 mm and G1Bx110 mm, it must be checked if the thread run-out is sufficient.**

Couplings and gaskets are mounted as shown in the figure.

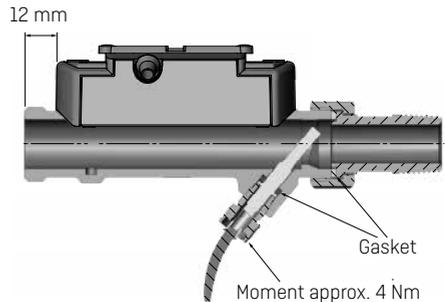

### 3.2 Mounting of ULTRAFLOW® ≤ DN125

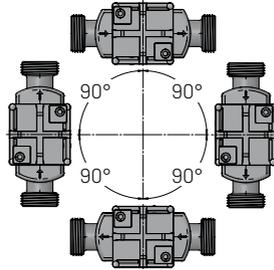

The flow sensor can be mounted horizontally, vertically or at an angle.

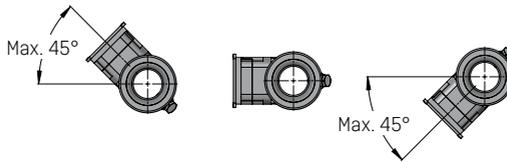

The flow sensor should be mounted with the plastic casing placed on the side [at horizontal mounting]. The flow sensor may be turned up to  $\pm 45^\circ$  in relation to the pipe axis, if necessary\*.

\* Flow sensors of the type 65-5-XXHX-XXX in the sizes  $q_p$  0.6...2.5 m<sup>3</sup>/h must not be turned upwards.

**Note:** In installations in which the media temperature is below the ambient temperature, ULTRAFLOW® in a condensation-proof version must be used. At the same time, ULTRAFLOW® must not be mounted with the plastic casing turned to below 0°. It is recommended to turn the plastic casing 45° upwards.

### 3.3 Mounting of ULTRAFLOW® 54 ≥ DN150

See Installation and user guide no. 5512-887

### 3.4 Flow sensor position

Kamstrup flow sensors require neither straight inlet nor straight outlet to meet the Measuring Instruments Directive (MID) 2014/32/EU, OIML R75:2002 and EN 1434:2015. A straight inlet section will only be necessary in case of heavy flow disturbances before the meter. It is recommended to follow the guidelines of CEN CR 13582.

- A** Recommended position.
- B** Recommended position.
- C** Unacceptable position due to risk of air build-up.
- D** Acceptable position in closed systems.
- E** Ought not to be placed immediately after a valve, with the exception of block valves (ball valve type) which must be fully open when not used for blocking.
- F** Ought not to be placed immediately before or after a pump.
- G** Ought not to be placed immediately after a double bend in two planes.

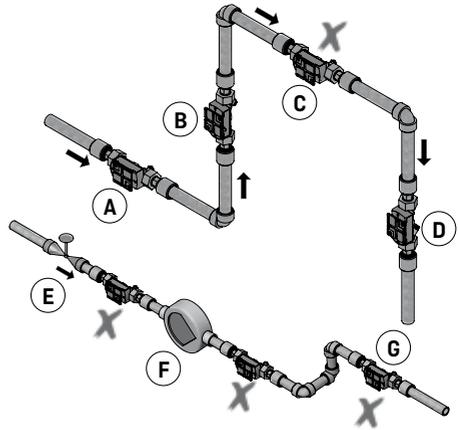

In order to avoid cavitation, the back pressure at the flow sensor (the pressure at the flow sensor outlet) must be minimum 1.5 bar at  $q_p$  (nominal flow) and minimum 2.5 bar at  $q_g$  (maximum flow). This applies to temperatures up to approx. 80 °C. The flow sensor must not be exposed to pressure lower than the ambient pressure (vacuum).

### 3.5 Installations with two ULTRAFLOW® sensors

MULTICAL® can be used in various applications with two ULTRAFLOW® sensors, including leak surveillance and open systems. As a main rule, when two ULTRAFLOW® sensors are installed with one MULTICAL®, a close electric coupling between the two pipes ought to be carried out on which the two flow sensors are mounted. If the two pipes are installed in a heat exchanger, close to the flow sensors, however, the heat exchanger will provide the necessary electric coupling.

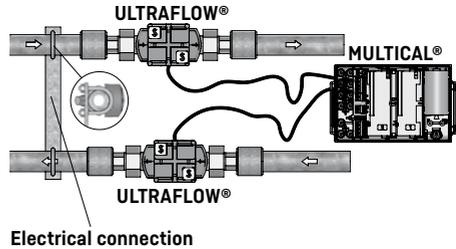

- Inlet and outlet pipes are closely electrically coupled.
- The parts of the pipe installation that are electrically connected to the flow sensors must not be subjected to soldering.

In installations where the electric coupling is not possible or welding\* can occur in the pipe system, the cable from one ULTRAFLOW® must be led through a Pulse Transmitter to obtain galvanic separation before the cable is connected to MULTICAL®.

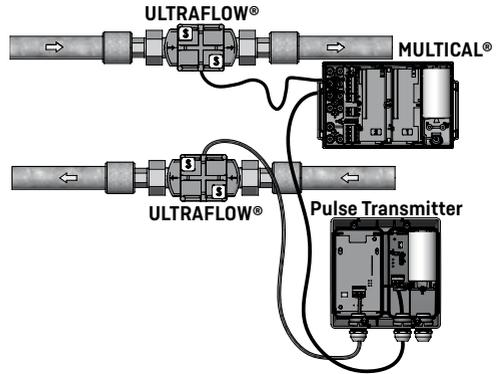

\* Electric welding must always be carried out with the earth pole closest to the welding point. Damage to meters due to welding is not comprised by the factory guarantee.

## 4 Mounting the calculator

The MULTICAL® calculator can be mounted in different ways; either directly on ULTRAFLOW® (compact mounting) or on a wall (wall-mounting).

### 4.1 Compact mounting

At compact mounting, the MULTICAL® calculator is mounted directly on ULTRAFLOW® by sliding the calculator onto the fitting of the plastic casing of the flow sensor. Having been mounted, the calculator is sealed with seal and locking wire or sealing label. At the risk of condensation [e.g. in cooling applications], the calculator must be wall-mounted. In addition, a condensation-proof flow sensor must be used in cooling applications.

**Note:** In case of compact mounting, it may be necessary to use the enclosed angle fitting with some types of ULTRAFLOW® to obtain the required combination of viewing angle for the calculator's display and installation angle for ULTRAFLOW®.

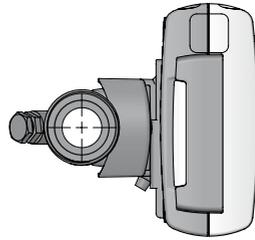

### 4.2 Wall-mounting

MULTICAL® can be mounted on an even wall. Wall-mounting requires a wall fitting which is available as an accessory to MULTICAL®. Use the wall fitting as a template to mark and drill two 6 mm holes in the wall. Then mount the wall fitting with the enclosed screws and rawlplugs. Mount MULTICAL® on the wall fitting by sliding the calculator onto the fitting in the same way as it is done by compact mounting.

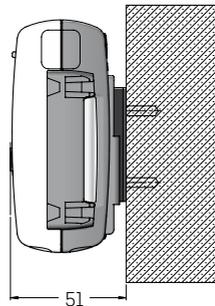

## 5 Electrical connection

### 5.1 Connection of temperature sensors

Temperature sensors are connected to MULTICAL® via the connection PCB. According to meter type, the terminal numbers in the table for temperature sensor connection are used.

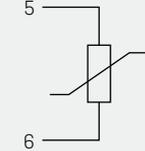
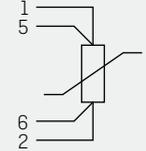
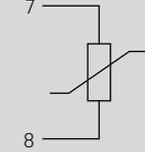
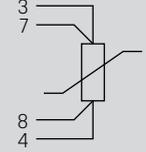
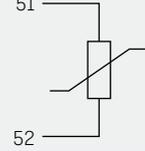
Sensor	2-wire Terminal number	4-wire Terminal number
t1		
t2		
t3		

### 5.2 Connection of ULTRAFLOW®

ULTRAFLOW® is connected to MULTICAL® via the connection PCB using the terminal numbers in the table.

	Wire	ULTRAFLOW®
9 +	Red	V1
10 Sig	Yellow	
11 -	Blue	
9 +	Red	V2
69 Sig	Yellow	
11 -	Blue	

### 5.3 Cable Extender Box

If a cable longer than 10 m is required between MULTICAL® and ULTRAFLOW®, it is possible at lengths between 10 and 30 m to use Cable Extender Box. See further information in the document 5512-2008.

### 5.4 Electrical connection of Pulse Transmitter

If ULTRAFLOW® 54 is used together with third-party equipment, it must be connected through a Pulse Transmitter or Pulse Divider. See instructions 5512-1387 for further information.

## 5.5 Connection of other flow sensors

Other passive flow sensors with either reed switch or transistor output can be connected to MULTICAL® via the terminal numbers in the table. Be aware of correct mounting of + and - of flow sensors with transistor outputs.

Flow sensor	
10 + 11 -	V1
69 + 11 -	V2

Some types of MULTICAL® can be connected to other flow sensors with 24 V active pulse outputs using the terminal numbers in the table. Be aware of correct mounting of + and -.

Flow sensor	
10B + 11B -	V1

## 5.6 Connection of power supply

### 5.6.1 Battery supply

MULTICAL® can be delivered battery-supplied with a number of various batteries. Optimal battery lifetime is obtained by keeping the battery temperature below 30 °C, e.g. by wall mounting. The voltage of a lithium battery is almost constant throughout the lifetime of the battery (approx. 3.65 VDC). Therefore, it is not possible to determine the remaining capacity of the battery by measuring the voltage. However, the information code of the meter indicates if the battery level is low, see the paragraph "Information code". The battery cannot and must not be charged and must not be short-circuited. Used batteries must be handed in for approved destruction, e.g. at Kamstrup A/S. Further details appear from document on handling and disposal of lithium batteries [5510-408].

### 5.6.2 Mains supply

MULTICAL® is available with supply modules for either 24 VAC\* or 230 VAC.

The supply modules are protection class II and are connected via a two-wire cable (without earth) through the big cable bush at the bottom of the connection base. Use connecting cable with an outer diameter of 5-8 mm and ensure correct cable stripping as well as correct mounting of cable relief. If connecting to 230 VAC, it is important to make sure that the whole installation complies with current regulations. MULTICAL® can be delivered with 2 x 0.75 mm<sup>2</sup> supply cable. The supply cable for the meter must never be protected by a fuse larger than the one permitted.

In case of doubt, it is recommended to take advice from an authorised electrician and get an individual assessment of the execution of the installation in question. In addition, note that work on fixed installations and any intervention in the fuse box, must be carried out by an authorized electrician only.

For installation in Denmark: See "Installation of mains connected equipment for registration of consumption" from the Danish National Safety Board.

\* By use of a 24 VAC/VDC "high-power" supply module, MULTICAL® can also be supplied from 24 VDC.

## 5.7 Internal communication

According to type, MULTICAL® 603 has the possibility of internal M-Bus communication, M-Bus is connected via the connection PCB using terminals 24 and 25.

## 6 Testing of function

---

Carry out an operational check when the energy meter has been fully mounted. Open thermoregulators and valves to enable water flow through the heating system. Activate the front key of MULTICAL® to change display reading, and check that the displayed values for temperatures and water flow are credible values.

## 7 Information code

MULTICAL® constantly monitors a number of important functions. If errors occur in the measuring system or installation, a flashing "INFO" appears in the display. The "INFO" field keeps flashing as long as the error is present, no matter which reading you choose. The "INFO" field automatically switches off when the error has been corrected. For indicating current errors in MULTICAL®, it is possible to scroll to the information code in the display, this is the display in which INFO does not flash, but is shown permanently. The information code display is available both in the USER loop and TECH loop. The info code consists of 8 digits, and each functionality has its own digit dedicated to the indication of relevant information. For instance all information concerning temperature sensor t1 is shown in the display as the second digit from the left.

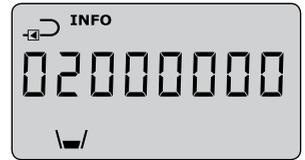

Display digit								Description
1	2	3	4	5	6	7	8	
<b>Info</b>	<b>t1</b>	<b>t2</b>	<b>t3</b>	<b>V1</b>	<b>V2</b>	<b>In-A</b>	<b>In-B</b>	
1								No voltage supply
2								Low battery level
9								External alarm [e.g. via KMP]
	1							t1 Above measuring range or switched off
		1						t2 Above measuring range or switched off
			1					t3 Above measuring range or switched off
	2							t1 Below measuring range or short-circuited
		2						t2 Below measuring range or short-circuited
			2					t3 Below measuring range or short-circuited
	9	9						Invalid temperature difference [t1-t2]
				1				V1 Communication error
					1			V2 Communication error
				2				V1 Wrong pulse figure
					2			V2 Wrong pulse figure
				3				V1 Air
					3			V2 Air
				4				V1 Wrong flow direction
					4			V2 Wrong flow direction
				6				V1 Increased flow
					6			V2 Increased flow
				7				Burst, water runs out of the system
					7			Burst, water runs into the system
				8				Leakage, water runs out of the system
					8			Leakage, water runs into the system
						7		Pulse input A2 Leakage in the system
						8		Pulse input A1 Leakage in the system
						9		Pulse input A1/A2 External alarm
							7	Pulse input B2 Leakage in the system
							8	Pulse input B1 Leakage in the system
							9	Pulse input B1/B2 External alarm

## 8 Communication Modules

MULTICAL® 603 can be extended by a wide range of extra functions by means of communication modules. Below, pulse inputs/outputs and module types are briefly described.

**Note:** Before replacing or mounting modules, the supply to the meter must be switched off. The same applies for mounting of an antenna.

### 8.1 Module overview

MULTICAL® 603 communication modules

Type No.	Description
HC-003-10	Data + 2 pulse inputs (In-A, In-B)
HC-003-11	Data + 2 pulse outputs (Out-C, Out-D)
HC-003-20	M-Bus, configurable + 2 pulse inputs (In-A, In-B)
HC-003-21	M-Bus, configurable + 2 pulse outputs (Out-C, Out-D)
HC-003-22	M-Bus, configurable w/ Thermal Disconnect
HC-003-30	Wireless M-Bus, configurable, 868 MHz + 2 pulse inputs (In-A, In-B)
HC-003-31	Wireless M-Bus + pulse outputs
HC-003-40	Analog outputs 0/4...20 mA
HC-003-41	Analog inputs 4...20 mA or 0...10 V
HC-003-43	PQT Controller
HC-003-60	LON FT-X3 + 2 pulse inputs
HC-003-66	BACnet MS/TP + 2 pulse inputs
HC-003-67	Modbus RTU (RS-485) + 2 pulse inputs (In-A, In-B)

### 8.2 Pulse inputs

Pulse inputs A and B are used for connection of extra meters with either Reed-switch output or passive electronic pulse output.

Min. pulse duration is 30 ms. and max pulse frequency is 3 Hz.

65 +  
66 - Pulse input C

67 +  
68 - Pulse input D

If a module with pulse inputs is mounted in MULTICAL®, the meter is automatically configured for pulse inputs. Note that the pulse figure (litres/pulse) must match the extra water meters and the configurations of inputs A and B. After delivery, the configurations of pulse inputs A and B can be changed by means of the PC program METERTOOL HCW.

### 8.3 Pulse outputs

Pulse outputs for energy and volume are made with Opto Fet, the pulse outputs are available on a number of the communication modules.

Max. voltage and current of the outputs are 45 VDC and 50 mA respectively.

When a module with pulse outputs is mounted in MULTICAL®, the meter is automatically configured for pulse outputs. The pulse duration is ordered at 32 ms. or 100 ms. After delivery the pulse duration can be changed by means of the PC program METERTOOL HCW.

The resolutions of the pulse outputs always follow the least significant digit displayed for energy and volume respectively.

16 +  
17 - Pulse output C

18 +  
19 - Pulse output D

### 8.4 Data + pulse inputs, type HC-003-10

The data terminals are used for connection of e.g. a PC. The signal is passive and galvanically separated by means of optocouplers.

Conversion to RS232 level requires connection of data cable 66-99-106 [D-SUB 9F] or 66-99-098 [USB type A] with the following connections:

62	Brown	[DAT]
63	White	[REQ]
64	Green	[GND]



### 8.5 Data + pulse outputs, type HC-003-11

The data terminals are used for connection of e.g. a PC. The signal is passive and galvanically separated by means of optocouplers.

Conversion to RS232 level requires connection of data cable 66-99-106 [D-SUB 9F] or 66-99-098 [USB type A] with the following connections:

62	Brown	[DAT]
63	White	[REQ]
64	Green	[GND]

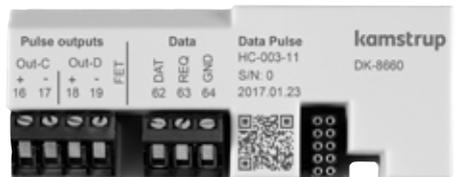

**8.6 M-Bus + pulse inputs, type HC-003-20**

M-Bus module with primary, secondary and enhanced secondary addressing.

The module is connected to an M-Bus master via terminals 24 and 25 using a twisted pair.

The polarity is without importance for the functionality.

The module is powered by the connected master.



**8.7 M-Bus + pulse outputs, type HC-003-21**

M-Bus module with primary, secondary and enhanced secondary addressing.

The module is connected to an M-Bus master via terminals 24 and 25 using a twisted pair.

The polarity is without importance for the functionality.

The module is powered by the connected master.



**8.8 M-Bus + Thermal Disconnect, type HC-003-22**

M-Bus module with primary, secondary and enhanced secondary addressing. The module is connected to an M-Bus master via terminals 24 and 25 using a twisted pair. The polarity is without importance for the functionality.

The meter must be supplied by 24 VAC or 230 VAC.

The module requires an external 24 VAC power supply for operating the connected actuator.



### 8.9 Wireless M-Bus + pulse inputs, type HC-003-30\*

The wireless M-Bus module has been designed to form part of Kamstrup's hand-held Wireless M-Bus Reader system, which operates within the unlicensed frequency band in the 868 MHz area. The radio module is available with either internal or external antenna. Please note that both antenna types use the same connection.



### 8.10 Wireless M-Bus + pulse outputs, type HC-003-31\*

The wireless M-Bus module has been designed to form part of Kamstrup's hand-held Wireless M-Bus Reader system, which operates within the unlicensed frequency band in the 868 MHz area. The radio module is available with either internal or external antenna. Please note that both antenna types use the same connection.

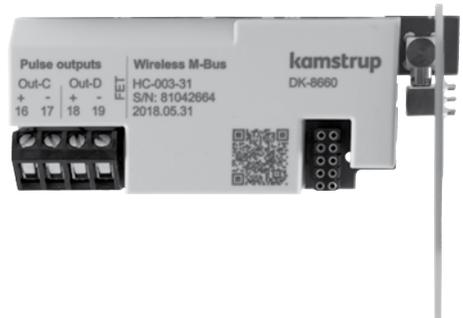

### 8.11 Analog outputs, type HC-003-40

Analog module with 2 pcs. 0/4..20 mA current outputs. The current is measured directly via the 2 sets of output terminals 80-81 and 82-83.

The meter must be supplied by 24 VAC or 230 VAC.

The module requires an external 24 VAC power supply for operating the analog outputs.



\*  The wireless M-Bus module must be connected to an internal or external antenna. When mounting an external antenna, ensure that the antenna cable is not jammed or damaged when the calculator is assembled. Before replacing or mounting modules, the supply to the meter must be switched off. The same applies to mounting of an antenna.

### 8.12 Analog inputs, type HC-003-41

Analog module with 2 inputs, configurable as either 4...20 mA or 0...10 V inputs. The inputs can be scaled according to the connected sensors. The sensors are connected to the module on the 2 sets of input terminals 60-58-57 and 60-59-57. The measured values can be read in the meter's P1 and P2 registers. The meter must be supplied by 24 VAC or 230 VAC.

The module requires an external 24 VAC/VDC power supply for operating the module and the connected sensors.



### 8.13 PQT Controller, type HC-003-43

PQT Controller module with output for controlling three-point motor-operated valve. The module is used to regulating the power, flow and temperature in the installation. The motor-operated valve is connected to the terminals 150, 151 and 152. Check of the motor-operated valve's direction of rotation can be made by short-circuiting the test points Up or Dn.

The meter must be supplied with 24 VAC or 230 VAC.

The module requires an external 24 VAC power supply for operating the connected motor-operated valve.



### 8.14 LON TP/FT + pulse inputs, type HC-003-60

LON is often used in building automation systems and industrial applications.

The LON module is compatible with EN 14908/EU.

The module is delivered with bar codes with imprinted LON Node ID to ease the commissioning. To activate the LON service pin, you must call the “CALL” feature on the meter.

The module supports free topology on twisted pair cables with speeds up to 78115 baud. The twisted pair cables can be looped into the terminals 55 and 56.

The meter must be supplied by 24 VAC or 230 VAC high-power supply.

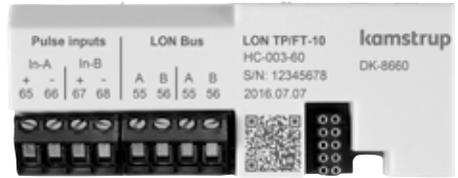

### 8.15 BACnet MS/TP + pulse inputs, type HC-003-66

BACnet is often used in building automation systems and industrial applications.

The BACnet module is compatible with ASHRAE 135. The module is BACnet-certified and registered in the BTL list.

The module communicates via RS485 with speeds up to 115200 baud. The shielded twisted pair cables are connected to the terminals 137, 138 and 139.

The meter must be supplied by 24 VAC or 230 VAC.



### 8.16 Modbus RTU + pulse inputs, type HC-003-67

Modbus is often used in building automation systems and industrial applications. The module is a Modbus RTU slave device that is verified against the Modbus Implementation Guide V1.02.

The module communicates via RS485 with speeds up to 115200 baud. The shielded twisted pair cables are connected to the terminals 137, 138 and 139.

The meter must be supplied by 24 VAC or 230 VAC.

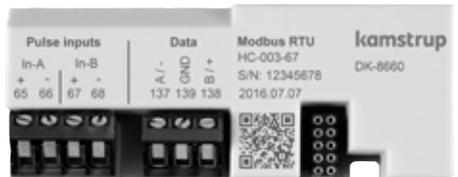

## 9 Set-up via front keys

A number of parameters in MULTICAL® 603 can be configured at the installation site. The configuration is carried out via SETUP loop, which is available as long as MULTICAL® 603 remains in transport state\*, or until the configuration is ended by activating "End setup".

You can navigate from USER loop to SETUP loop by keeping the primary key activated for 5 seconds until the text 1-USER appears on the display. Then use the arrow keys to navigate to 3-SETUP and press the primary key once to open the SETUP loop in MULTICAL® 603. Use the arrow keys to switch to the parameter that you want to change. You can reach the parameter by pressing the primary key. Then you can switch to the individual figures by pressing the arrow keys, e.g. minutes under time (3-004). The parameter is set by pressing the primary key shortly several times. Leave the menu item by keeping the primary key activated until OK is shown in the display. After 4 min. without activation of the front keys the meter returns to energy reading in USER loop.

SETUP loop	Index number in display
1.0 Customer number [N° 1]	3-001
2.0 Customer number [N° 2]	3-002
3.0 Date	3-003
4.0 Time**	3-004
5.0 Yearly target date 1 [MM.DD]	3-005
6.0 Monthly target date 1 [DD]	3-006
7.0 Flow sensor position: Inlet or outlet flow [A-code]	3-007
8.0 Energy unit [B code]	3-008
9.0 M-Bus primary address internal [N° 34]	3-009
10.0 Primary address module slot 1 [N° 34]	3-010
11.0 Primary address module slot 2 [N° 34]	3-011
12.0 Averaging time of min./max. P and Q	3-012
13.0 $\theta_{hc}$ ***	3-013
14.0 t offset	3-014
15.0 Radio "ON" or "OFF"	3-015
16.0 Input A1 [preset register]	3-016
17.0 Input B1 [preset register]	3-017
18.0 Meter number of Input A1	3-018
19.0 Meter number of Input B1	3-019
20.0 TL2	3-020
21.0 TL3	3-021
22.0 TL4	3-022
23.0 t5	3-023
24.0 EndSetup	3-024

\* MULTICAL® 603 is in transport state until a flow of 1 % of  $q_p$  or more has been registered for the first time. Then the SETUP loop of the meter can only be accessed by breaking the installation seal and separating and immediately after reassembling the top and base of the calculator.

\*\* The clock can, under installation seal, be adjusted by all modules.

\*\*\*  $\theta_{hc}$  can only be changed on meter type 6. If you attempt to access this menu on the meter types, the display shows the message "Off".

# User Guide

## Energy measurement

MULTICAL® 603 functions as follows:

**The flow sensor** registers the quantity of water which circulates through the system in cubic metres (m<sup>3</sup>).

**The temperature sensors** placed in inlet and outlet pipes register the cooling, i.e. the difference between inlet and outlet temperatures.

**MULTICAL® 603** calculates energy consumption on the basis of volume of water and temperature difference.

## Readings in the display

When on of the arrow keys (◀ or ▶) is activated, a new primary reading is displayed. The primary key (⊙) is used for retrieving historical readings and average values and for returning to primary readings.

Four minutes after the latest activation of any front key, reading automatically changes to consumed energy.

## Display readings

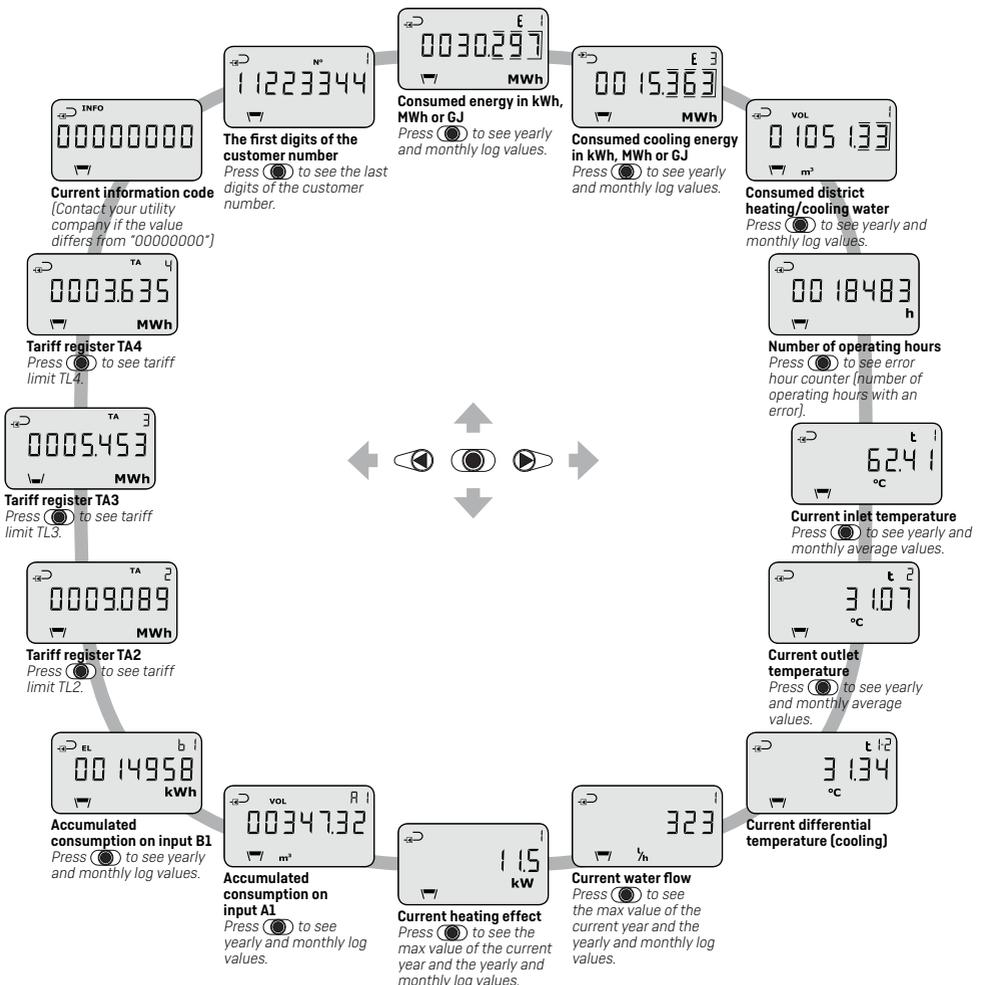

Display readings are based on **DDD-code 310 / 610**. At [kamstrup.com](http://kamstrup.com), you can find a selection of interactive user guides based on other DDD-codes.

User Guide

MULTICAL® 603

